





Product images are for illustration purposes only. Actual product(s) may vary.

WHITE FINISH	
MODEL No.	
5261	
LEFT HAND DRAIN LOCATION	
5271	
RIGHT HAND DRAIN LOCATION	

BISCUIT FINISH	
MODEL No.	
5263	LEFT HAND DRAIN LOCATION
5273	RIGHT HAND DRAIN LOCATION
<i>COLOUR OPTIONS ARE MADE TO ORDER - NO REFUND - NO RETURN -</i>	

DIMENSIONS	WATER DEPTH	CAPACITY
<ul style="list-style-type: none"> • Length: 72" / 1829mm • Width: 32" / 813mm • Skirt Height: 22" / 559mm 	14" / 356mm Drain to overflow	59 gal. 223 litres of water

PRODUCT INFORMATION:	
<ul style="list-style-type: none"> • Modern style • Plain skirt • End drain • Made in Canada 	<ul style="list-style-type: none"> • Comes with integral armrests • High gloss / Crack-resistant acrylic • Complies with CSA & IAPMO standards

SHIPPING INFORMATION:	
<ul style="list-style-type: none"> • Length: 74" / 1880mm • Width: 34" / 864mm • Height: 26" / 660mm 	<ul style="list-style-type: none"> • Net Weight: 40 kg / 88 lbs. • Gross Weight: 45 kg / 99 lbs

MODEL NUMBER : **5261**
(LEFT HAND DRAIN LOCATION)

MODEL NUMBER : **5271**
(RIGHT HAND DRAIN LOCATION)

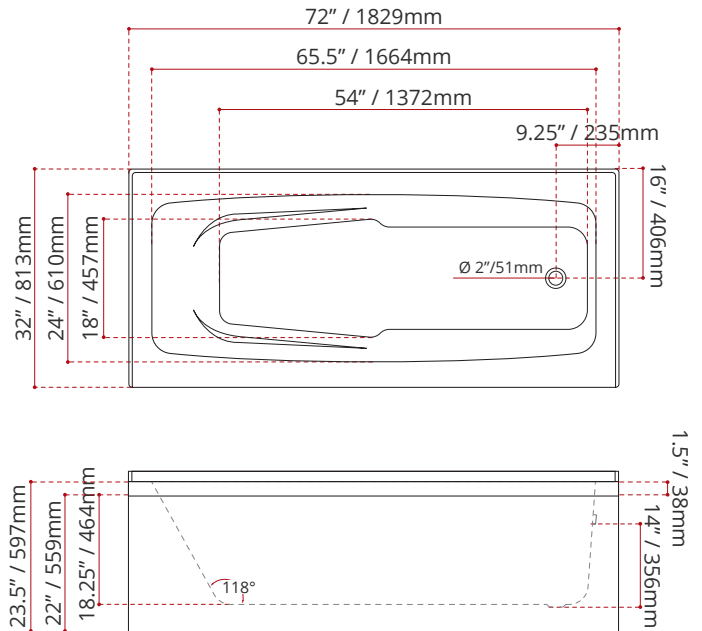
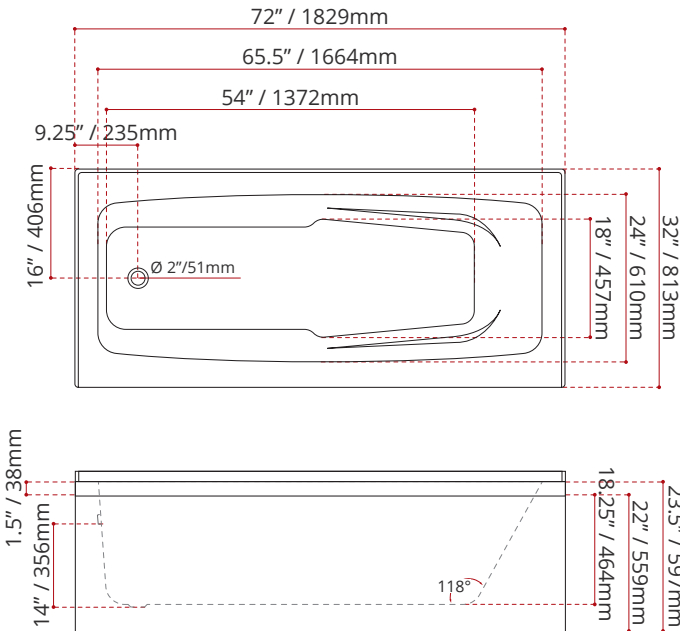

DISCLAIMER: Measurements may vary ± 1/4" (Diagram Not to scale)

CUSTOMIZE YOUR TUB

ALL UPCHARGE OPTIONS ARE MADE TO ORDER - NO REFUND - NO RETURN -

AVAILABLE CUSTOMIZATION OPTIONS	MODEL No.
3/4" SET BACK WOOD APRON	C1
WOOD APRON REMOVABLE ACCESS PANEL	C2
SKIRT CUT-OFF	C3
TEXTURED BOTTOM	C4
DOUBLE TILING FLANGE	C5
¾" SET BACK WOOD APRON + TEXTURED BOTTOM	C14
¾" SET BACK WOOD APRON + DOUBLE TILING FLANGE	C15
REMOVABLE ACCESS PANEL + TEXTURED BOTTOM	C24
REMOVABLE ACCESS PANEL + DOUBLE TILING FLANGE	C25
SKIRT CUT-OFF + TEXTURED BOTTOM	C34
SKIRT CUT-OFF + DOUBLE TILING FLANGE	C35
TEXTURED BOTTOM + DOUBLE TILING FLANGE	C45
¾" SET BACK WOOD APRON + TXRED BTM + DBL TILING FLANGE	C145
REMOVABLE ACCESS PANEL + TXRED BTM + DBL TILING FLANGE	C245
SKIRT CUT-OFF + TEXTURED BOTTOM + DBL TILING FLANGE	C345

JETTING OPTIONS

ALL EXPERIENCES ARE MADE TO ORDER - NO REFUND - NO RETURN -

MODEL No.	DESCRIPTION
E15	16 LATERAL AIR JETS (CHROME) + 1 ROUND LIGHT (WHITE) + 6 THIN LINE TURBO JETS (CHROME)
E33	16 AIR ILLUSION JETS + 2 ROUND LIGHTS (WHITE) + 6 STANDARD THIN LINE JETS (WHITE)
E56	16 SANTE AIR JETS (WHITE) + 1 ROUND LIGHT (WHITE) + 6 STANDARD THIN LINE JETS (WHITE)
E75	16 ZEN AIR JETS (CHROME) + 2 ROUND LIGHTS (WHITE) + 6 SQUARE STANDARD JETS (CHROME)
M16	4 V-MASSEUSE + 16 AIR ILLUSION JETS + 2 ROUND LIGHTS (WHITE)
M33	4 WHIRLPOOL V-MASSEUSE + 16 LATERAL AIR JETS (CHROME) + 1 ROUND LIGHT (WHITE)
062	6 REGULAR WHIRLPOOL WATER JETS - BRUSHED NICKEL
032	16 SANTE AIR JETS (WHITE FINISH) + 1 ROUND LIGHT (WHITE FINISH)

*FOR MORE EXPERIENCES, JETTING OPTIONS & ACCESSORIES
PLEASE REFER TO THE JETTING GUIDE*

HOW TO CREATE THE MODEL NUMBER

When configuring a bathtub please follow the correct order of the configuration options.

COLOUR OPTION + CUSTOMIZATIONS + JETTING OPTIONS

Let's break down an example — Here is Model No.

5261C45E56

5261C45E56 (PSTARK7232 LEFT HAND DRAIN WHITE FINISH)

5261**C45**E56 (TEXTURED BOTTOM + DOUBLE TILING FLANGE)

5261C45**E56** (JETTING OPTION)

PSTARK7232SK LEFT HAND DRAIN WHITE FINISH + TEXTURED BOTTOM + DOUBLE TILING FLANGE + 16 SANTE AIR JETS (WHITE) + 1 ROUND LIGHT (WHITE) + 6 STANDARD THIN LINE JETS (WHITE)